

# MPX™ Reformer

## with Vertical Stand



Please review this important **assembly, safety** and **warranty** information about your new Merrithew™ equipment and keep it handy for future reference.

## IMPORTANT!

This manual contains important assembly, safety and warranty information. Read the manual carefully before using your new equipment and keep the manual on hand for future reference.

**UNSAFE OR IMPROPER USE OF THIS EQUIPMENT BY FAILING TO READ AND COMPLY WITH ALL REQUIREMENTS AND WARNINGS COULD RESULT IN SERIOUS INJURY.**

It is impossible to predict every situation and condition that can occur while using this equipment. Merrithew™ makes no representation about the safe use of any exercise equipment that cannot be predicted or avoided.

**PLEASE DO NOT ATTEMPT TO ASSEMBLE ON YOUR OWN. SOME OF THESE STEPS REQUIRE TWO PEOPLE. PLEASE READ THESE INSTRUCTIONS COMPLETELY BEFORE BEGINNING ASSEMBLY.**

Merrithew recommends cautious assembly and usage and wishes you many hours of safe and effective exercise.

## User Guidelines

This equipment when used effectively can facilitate many Pilates exercises safely and effectively. However, care and caution must be taken as there are some inherent dangers when using any exercise equipment, especially when spring resistance is involved.

**For inexperienced or first-time users, this equipment should only be used under the supervision of a trained professional.**

This manual includes general guidelines for setup and usage. To get the most out of this equipment, Merrithew offers instructional DVDs and manuals. Personalized training is offered through our Licensed and Corporate Training Centers. Visit [merrithew.com](http://merrithew.com) for more information.

## Care and Cleaning

Wipe vinyl surfaces using warm water with mild soap and clear water rinses for day-to-day cleaning. Ensure soap does not leave an oily residue, or make surfaces slippery.

Clean channels, rails and rollers daily with a damp cloth. Avoid spraying liquid directly onto surfaces. Never use oil lubricants as they may damage rollers.

**CAUTION:** We do not recommend using chemical-based products. Chemical-based cleansers used around Reformer feet may cause permanent marking on floors. The warranty does not cover this damage. We suggest placing a non-slip mat under the machine.

## IMPORTANT

**Replace all springs every 24 months and spring clips every 12 months, or as needed within that period.**

**FAILURE TO PERFORM RECOMMENDED SAFETY CHECKS, OR USING EQUIPMENT WITH IMPROPERLY ADJUSTED, BROKEN OR WORN PARTS, COULD RESULT IN SERIOUS BODILY INJURY.**



## CAUTION IMPROPER USE OF EXERCISE EQUIPMENT MAY CAUSE SERIOUS BODILY INJURY. TO REDUCE RISK, PLEASE READ THE FOLLOWING:

- ▶ Before starting any exercise program, consult a physician. Stop exercising immediately if you experience chest pain, feel faint, have difficulty breathing or experience any discomfort.
  - ▶ Before using equipment, read and follow the safety instructions in this manual and obtain thorough instruction from a qualified trainer. Use equipment for intended exercises only.
  - ▶ Do not use if equipment appears worn, broken or damaged. Do not attempt to repair equipment yourself without contacting Merrithew.
  - ▶ For optimal performance, allow at least two feet of clear space on either side of a Merrithew Reformer. Before moving a Reformer, ensure ropes do not drag, springs are attached and carriage is secure.
  - ▶ Ensure the equipment is properly adjusted for your size and ability level.
  - ▶ Keep body, clothing and hair free from all moving parts.
  - ▶ This equipment is to be used by one person at a time. Do not allow children to use or be around equipment without adult supervision.
  - ▶ The maximum weight limit of the MPX Reformer is 250 lb / 113 kg.
- WARNING: As with any athletic activity, the use of exercise equipment involves risk of injury, damage and / or death.**
- By choosing to use Merrithew equipment, you assume responsibility for that risk, not the people who sold you the equipment, distribute and/ or manufacture it.**

# Getting On the Reformer

**STOP! Before getting on, ensure the carriage stopper is inserted and at least one spring is securely attached to the gearbar.**

## Standing or Kneeling Positions

The carriage is a moving platform. Special attention must always be paid to maintaining your balance and stability, especially when performing kneeling or standing exercises.

1. Before beginning, ensure carriage stopper is inserted and one or more springs are engaged in the gearbar to secure the carriage.
2. Step carefully with one foot onto carriage. A gripper mat may be used to prevent slipping. (See *optional accessories*, page 14).
3. Place other foot carefully onto the wooden standing platform.

**Never attempt to get on the MPX Reformer by stepping on the wooden standing platform. Never stand with both feet on wooden standing platform.**

## Secure Hands and Feet

When placing hands or feet on the footbar, shoulder rests or headrest, ensure they do not slip. Gripper mats may be used.

## Sitting or Lying on a Box

Always place Reformer Box in a stable position on the Reformer and sit directly in the middle to avoid tipping. Ensure footstrap is underneath the wooden standing platform and securely clipped together.

## Supine Position (lying on back)

1. Sit on Reformer carriage, legs off to one side.
2. Reach hand nearest the footbar across your body and place it onto the shoulder rest.
3. Tuck opposite shoulder under arm and roll onto back lowering head onto headrest.
4. Bring legs up, place feet on footbar, lower arms by sides.



## Mechanical Safety Check

**Proper maintenance and timely replacement of your equipment or component parts is your responsibility.**

**Conduct a regular inspection of the following:**

### Daily

- ▶ Wipe rails with a damp cloth using water only.
- ▶ Clean fixed and floating rollers using a soft, damp cloth.
- ▶ Ensure carriage stopper is fully inserted in one of the six positions at all times.
- ▶ Ensure shoulder rests are fully inserted on carriage.
- ▶ Ensure footbar is securely fastened.
- ▶ Ensure chrome adjuster bar is securely seated in cradle.
- ▶ Inspect retractable rope system to confirm ropes are in position and threaded bolts of the cleats and pulley blocks are secure.
- ▶ Clean upholstery after each use, using a soft cloth and gentle cleanser.

### Weekly

- ▶ Ensure all nylon locknuts, spring bolts and spring balls are securely fastened.
- ▶ Ensure feet are securely attached with the flat side facing towards the floor.

- ▶ Ensure footbar and chrome adjuster bar are securely fastened.
- ▶ Ensure pulley post star knobs are securely tightened.
- ▶ Inspect rollers for excessive wear and replace as needed. Sit on carriage and test rollers, listening for any thumping or grinding – the ride should be quiet and whisper smooth.
- ▶ Inspect all springs for wear and damage and replace immediately as needed.
- ▶ Clean rails and rollers with a damp cloth.

### Monthly

- ▶ Check ropes and straps for wear and replace as necessary.
- ▶ Check that spring bolts and spring balls are securely fastened.
- ▶ Check all spring clips to ensure proper fastening.
- ▶ Check wear on star knobs threads and replace as necessary.

**Yearly** ▶ Replace all spring clips.

**Every Two Years** ▶ Replace all springs.

# MPX™ Reformer

- |                                |  |
|--------------------------------|--|
| 1 Star Knobs 1/2"              | 20 Shoulder Rests                      |
| 2 Accessory Board Receptacles  | 21 Serial Number Sticker               |
| 3 Stand                        | 22 Star Knobs 3/8" [fig. C & G]        |
| 4 Easy-Roll Wheels             | 23 Ropes                               |
| 5 Wooden Standing Platform     | 24 Traditional Pulleys                 |
| 6 Gearbar Slots [fig. B]       | 25 Stand Up Pulley Springs             |
| 7 Springs [fig. B]             | 26 Pulleys                             |
| 8 Footbar                      | 27 Gearbar [fig. B]                    |
| 9 Chrome Adjuster Bar          | 28 Rope Guide Tubes [fig. C]           |
| 10 1/4" Socket Head Cap Screws | 29 5/8" Bronze Bushings [fig. D]       |
| 11 Spring Sleeves              | 30 Floating Rollers [fig. D]           |
| 12 Footbar Adjustment Cradles  | 31 Fixed Rollers [fig. E]              |
| 13 Floating Safety Tab         | 32 Rubber Carriage Stopper [fig. A]    |
| 14 Spring Holder [fig. E]      | 33 Carriage Stopper Positions [fig. A] |
| 15 Small Swing Arm Bars        | 34 Stopper Plates [fig. G]             |
| 16 Large Swing Arm Bars        | 35 Pulleybar Receptacles [fig. G]      |
| 17 Aluminum Rails              | 36 Double Loop Straps [fig. F]         |
| 18 Carriage                    |  |
| 19 Adjustable Headrest         |  |

**Note:** Parts may not be exactly as shown.

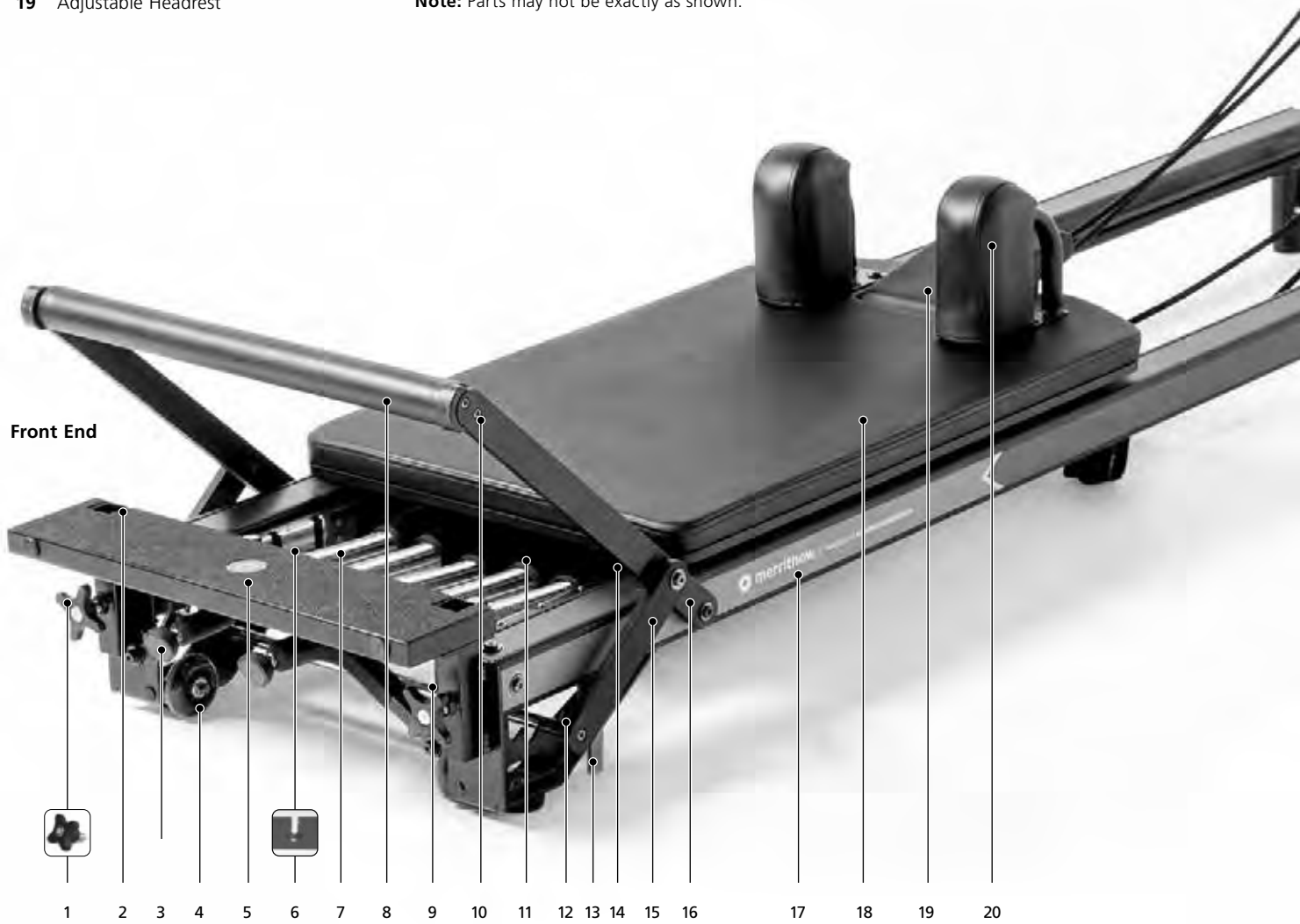





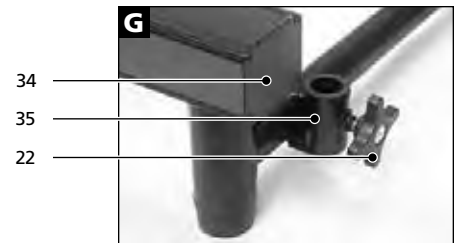
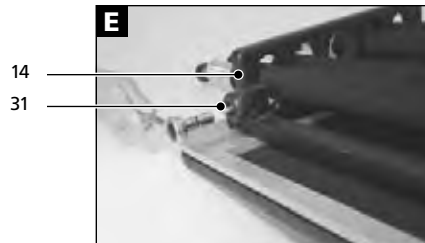
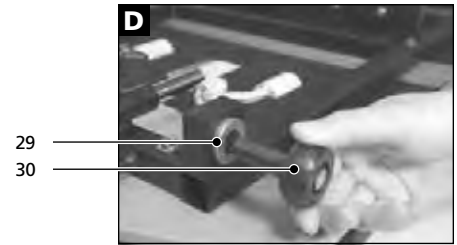
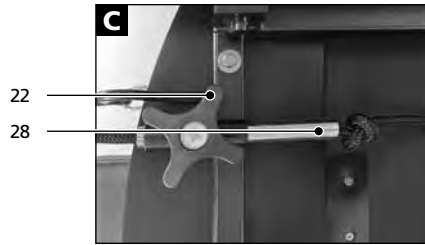
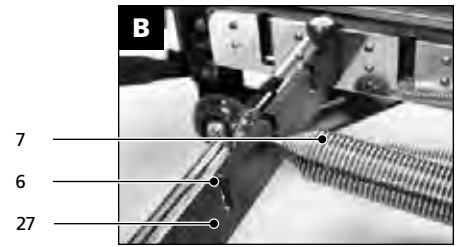
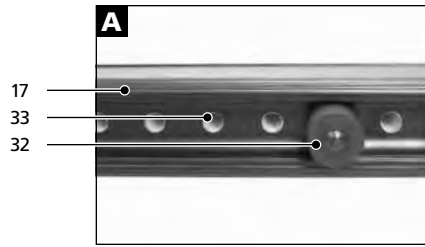

Back End



**Required Tools**

-  Phillips Screwdriver
-  1/4" (6 mm) Hex Key (supplied)
-  1/8" (3 mm) Hex Key (supplied)
-  Open-End Wrench 1/2" x 7/16"  
(13 mm x 11 mm)

# Assembling the MPX Reformer

**STOP!** Read these instructions completely before beginning or refer to our online assembly video at: [merrithew.com/eq-assembly](http://merrithew.com/eq-assembly)



**1.** Insert gearbar [27] into middle gearbar slot [6] with the caution sticker and concave indentations facing wooden standing platform [5].



**2.** Insert pulleybars [24] into receptacles [25] at rear of Reformer and tighten star knobs at base of receptacles. Ensure eyehooks on top of pulleybars are parallel to aluminum rails [17] and that star knobs are fully tightened so there is no movement of the pulleybars.

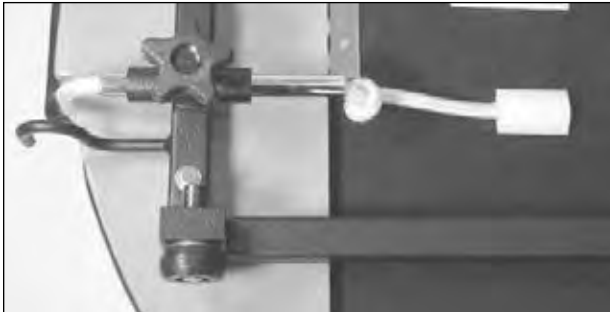

**3.** With two people, tilt Reformer onto one side. As one person steadies Reformer, the second person inserts free ends of ropes [23] through back of pulleys [26], then through rope guide tubes [28] underneath carriage.



**4.** Tie a knot leaving a 6-8" tail to prevent ropes from passing back through rope guide tubes.



**5.** Return Reformer to upright position.

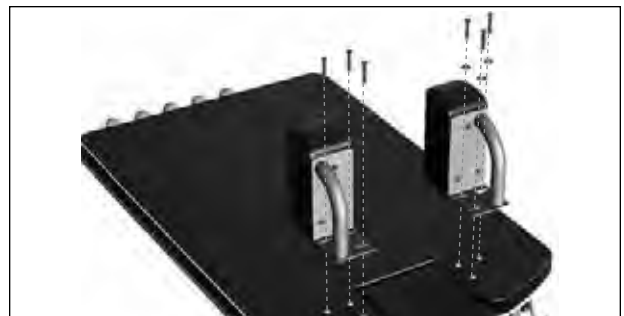

**6.** Position shoulder rests directly over pre-drilled screw holes.



**7.** Ensure shoulder rest handles are positioned to the outside of the shoulder rest frames.



**8.** Place 1/4" black washers over the shoulder rests screw hole slots.



**9.** Insert 1/4" x 1-1/4" screws through washers and into top of screw holes.

**10.** Use the 1/8" Allen key provided to tighten, ensuring the shoulder rests are secure.



**11.** To determine correct length of ropes, set carriage stopper in second hole from footbar. Engage a spring [7] into the gearbar [27] ensuring carriage [18] does not move.

**12.** Place double loop straps [36] on carriage so D-rings on straps line up with back of metal plate of shoulder rests.

Subtle adjustments can be made to length of ropes by sliding rope guide tubes [28]. Secure by tightening star knobs [22].

# Setting Up the Reformer

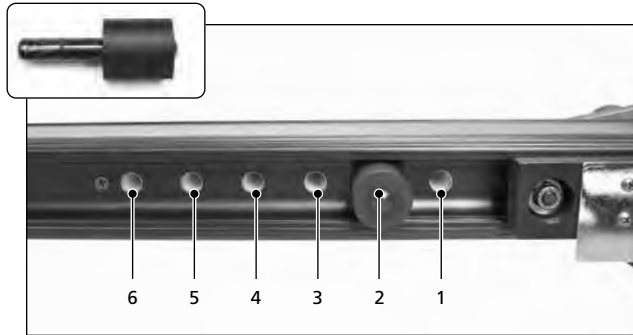

## Carriage Stopper

The carriage stopper position determines how close the carriage slides in toward the wooden standing platform and dictates the range of motion required of the body's joints. The hole closest to the wooden standing platform is referred to as position #1; the next hole is position #2, etc.

### Adjusting the Carriage Stopper

- ▶ Do not sit on carriage while adjusting.
- ▶ Remove all springs from gearbar.
- ▶ Insert carriage stopper in one of six positions.
- ▶ Be sure carriage stopper is completely inserted in the hole and is not loose.

The carriage stopper position should usually be selected so that when lying supine (on your back), with heels on the footbar, there is a 90° angle of flexion at the hip joint when the carriage is against the carriage stopper. If injury, disease or other limitations restrict flexion at the hips or knees, adjust the carriage stopper by placing it farther out. Adjustments can also be made for the exercise being performed.

**NOTE:** The carriage stopper must be inserted in one of the six positions AT ALL TIMES. Using the Reformer without the carriage stopper may cause damage to the gearbar assembly, rollers or spring holder.

**CAUTION:** Replace carriage stopper as required. Using a broken, damaged or defective carriage stopper may damage your Reformer.

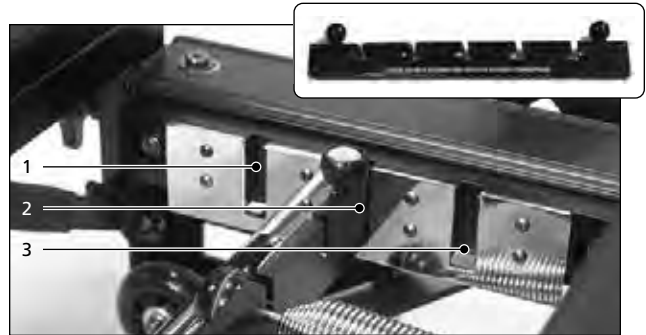

## Gearbar

The gearbar position determines the amount of initial tension on the springs. The slot closest to the wooden standing platform is position #1; the next is position #2; the next is position #3. Lower position numbers provide higher spring tension.

### Adjusting the Gearbar

- ▶ Do not sit on carriage while adjusting.
- ▶ Remove all springs from gearbar.
- ▶ Place gearbar in desired position.
- ▶ Ensure gearbar slides fully into slots.
- ▶ Ensure caution message and concave indentations face toward footbar.

Position gearbar relative to the carriage to create initial tension on the springs, i.e. the gearbar should not be in position #3 if the carriage stopper is in position #1 or #2 as there will not be any spring tension.

### Removing the Gearbar

remove all springs and then pull the gearbar away from the carriage and lift.





### Springs

Replace all Springs every 24 months.

The number of springs attached to the gearbar determines the total amount of resistance. MPX Reformers are equipped with four 100%-tension springs, and one 50% spring.

#### Adjusting Springs

- ▶ Take care when attaching and detaching springs from gearbar.
- ▶ For safety, place one hand on gearbar.
- ▶ Firmly grasp spring (not the ball on the spring) and stretch it to hook to or unhook from gearbar.
- ▶ Ensure ball end rests securely in concave indentations of gearbar.



### Headrest

The headrest adjusts to three positions: flat, half-raised or fully raised. It should be adjusted on an individual basis to ensure neck and shoulders are comfortable and tension-free when lying supine.

In exercises where the hips are lifted higher than the shoulders, headrest should be flat – even when beginning from a supine position. In some exercises it is raised to provide a brace for the feet.

#### Adjusting the Headrest

- ▶ With no weight on headrest, lift it and hinge adjustment block to rest securely onto wooden edge of carriage.

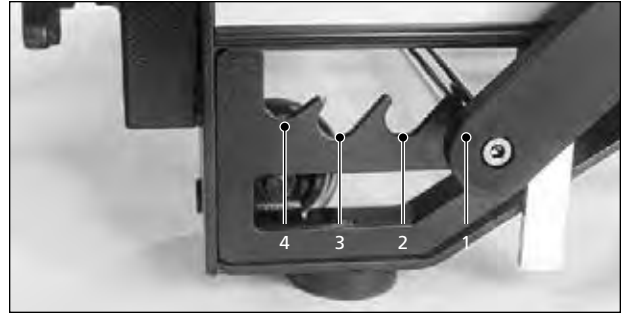

### Footbar

The footbar can be set at four different heights to facilitate various Reformer exercises and to accommodate physical differences and abilities. The cradle closest to the gearbar is position #1 the cradle farthest away is position #4.

#### Adjusting the Footbar

- ▶ The footbar can be adjusted while standing beside the Reformer or sitting on the carriage.
- ▶ Gently pull footbar up and lift chrome adjuster bar out of footbar adjustment cradle.
- ▶ Lift or lower footbar to the desired height and place chrome adjuster bar securely into nearest footbar adjustment cradle.

**NOTE:** It is highly recommended that the Reformer be placed on some type of non-skid material to prevent slipping and/or damage to flooring or carpet.



### Moving Reformers

The front end of all Reformers have a set of easy-roll wheels that make moving or repositioning simple for anyone of moderate strength.

- ▶ Ensure springs are attached so carriage is secure, and ropes do not drag.
- ▶ Stand at the back of Reformer, grasp the horizontal metal bar, and gently lift. Lift Reformer high enough to engage easy-roll wheels.
- ▶ Keep Reformer at waist-height or lower. Do not lift higher as this may result in damage to floor surface.



# MPX™ Reformer with Vertical Stand

**This Reformer model is equipped with a Vertical Stand, allowing it to be stored in an upright position.**

These instructions cover safe handling and storage of your equipment with the Vertical Stand.

## Safety and Usage

**Please note the following precautions.**

- ▶ Standing or lowering the Reformer requires two people. We recommend having someone to assist and spot when standing the Reformer upright.
- ▶ When standing and storing this Reformer, choose a low traffic area, away from children, pets, windows and mirrors.
- ▶ Select a level area of the room to store the Reformer, making sure the floor in the storage area is a solid flat surface and is completely clear.
- ▶ Softer surfaces such as carpet, sponge or other soft flooring are not recommended.
- ▶ Please ensure that you and your clients/patients receive proper instruction regarding the correct and safe use of this equipment.



## Part Identification

- 3 Stand
- 8 Footbar
- 9 Chrome Adjuster Bar
- 13 Floating Safety Tab (2)

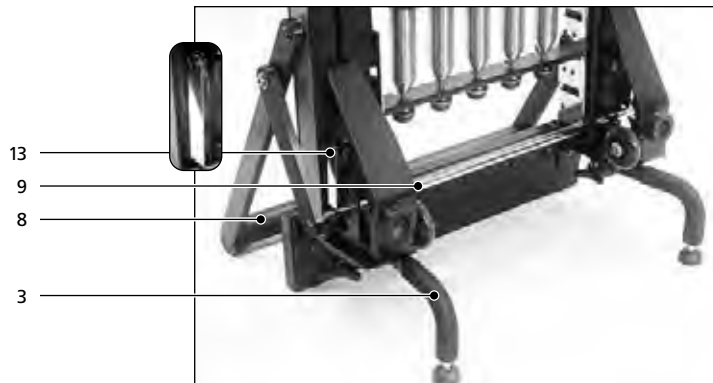

# Standing the Reformer Upright

Please read these instructions completely before beginning or refer to our online assembly video at [merrithew.com/eq-assembly](http://merrithew.com/eq-assembly)



**1.** Move the chrome adjuster bar [9] to set the footbar [8] into the lowest position.



**2.** Place the gearbar [27] in the second position.



**3.** Place the carriage stopper [32] in the second position.



**4.** Position all five springs [7] in the gearbar [27].



**5.** Grasp the front end crossbar with both hands and lift the Reformer. Keep the Reformer below 48"/122 cm (approximately waist-height) to prevent the frame from making contact with the floor. Roll the Reformer to the storage area.

**Take care when lifting the Reformer to avoid injury.**



**6.** To stand the Reformer, lift it upwards, while carefully moving one hand and then the other, to the side rails [17]. Continue lifting the Reformer until it is fully upright and resting on the footbar [8] [fig. A].

**Two people are required for this step. When standing and storing this Reformer, choose a low traffic area, away from children, pets, windows and mirrors.**

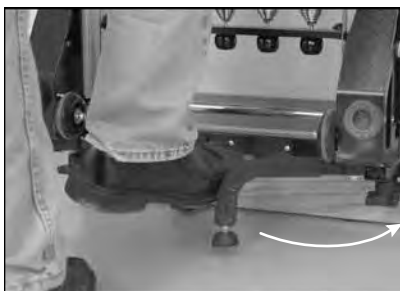

**7.** Using your foot, pull out one leg of the Stand [3], until it is fully folded out and in line with the Reformer rails [17]. Repeat for the Stand on the other side.

**It is strongly recommended that footwear is worn during this step.**



**8.** Ensure that the Floating Safety Tabs [13] on both sides are hanging vertically just above the chrome adjuster bar [9]. Wiggle the Reformer slightly to ensure the Reformer is solidly set in place.

**Be sure to select a level area when storing your Reformer upright.**

# Lowering the Reformer

To ensure your safety two people are required to lower a Reformer.



1. To prepare to lower the Reformer, position one hand on each of the side rails [17] of the Reformer.



2. Holding the Reformer in place, use your foot to push in one leg of the stand [3], until it is fully folded under the wooden standing platform [5]. Repeat for the stand on the other side.

**It is strongly recommended that footwear is worn during this step.**



3. Walk your hands up the rails [17] as you back up and lower the Reformer towards you.

**We recommend a second person assists you in holding the Reformer.**



4. Shift one hand to grasp the front end crossbar, then the other hand.



5. Continue lowering the Reformer. Bring to waist-height to prevent the frame from making contact with the floor, and roll the Reformer to its destination.



6. Reset the carriage stopper [32], footbar [8] and springs [7] as desired and attach the vertical frame or accessory boards if needed.

# Optional Reformer Accessories



## Padded Platform Extender

Extends the wooden standing platform to accommodate a variety of exercises, providing added comfort and safety. Can also be used on the carriage to bring the pelvis and spine to a neutral position when sitting.

- ▶ Remove footstrap (if applicable) and lower footbar completely.
- ▶ Place desired springs in gearbar.
- ▶ Place padded platform extender in a stable position on rails ensuring it is firmly in place against the wooden standing platform and does not move.
- ▶ Gripper mats may be used.

**NOTE:** Always step onto or stand directly in the center of the padded platform extender to avoid tipping.



## Gripper Mats

Versatile non-slip mats are handy to increase traction and prevent slipping or sliding (see image above for example of usage).



## Roll-Up Pole, Metal

Perfect to provide added scapular awareness, it can be used with multiple Reformer exercises. Available in two weights. Maple Roll-Up Pole also available.



## Mat Converter

Adding a mat converter covers the springs and creates a safe, stable surface for Matwork.

### Installing the Mat Converter

- ▶ Remove footstrap (if applicable).
- ▶ Place footbar down and disconnect springs.
- ▶ Slide carriage back against pulleybars, ensuring ropes are wrapped out of the way.
- ▶ Insert mat converter ensuring it is pressed completely into place.



## Accessory Boards

Optional accessory boards can be added to MPX Reformers to further increase exercise options.

- ▶ Jumpboard and Cardio-Tramp™ for plyometric and aerobic exercises.
- ▶ Rotational Diskboard™ allows greater range and asymmetrical movements when working in controlled internal and external rotation.
- ▶ Soft footbar accommodates sensitive feet.

### Installing Accessory Boards

- ▶ Lower footbar to lowest position.
- ▶ Insert accessory board into receptacles in wooden standing platform and ensure it slides down fully.
- ▶ Tighten star knobs located under wooden standing platform.

**NOTE:** Never use an accessory board without ensuring the star knobs have been tightened and are secure.



### Reformer Box

Reformer boxes can be used to facilitate or modify exercises.

#### Positioning the Reformer Box

- ▶ Place Reformer box on top of carriage with either long or short side facing forward.
- ▶ Box can be placed over or against shoulder rests in the “short box” position.



### Footstrap

Footstrap is included with purchase of a Reformer box.

#### Attaching the Footstrap

- ▶ Loop footstrap around wooden standing platform and adjust the length by attaching spring clip to one of the three D-rings.
- ▶ Footstrap should be adjusted so that there is tension with knees slightly flexed. It is important to keep feet hooked securely under footstrap.

## Replacement Parts



### Fixed Rollers

With carriage removed from rails, attach fixed roller with the aid of a ratchet and 12 mm (15/32") socket attachment. Ensure fixed rollers are securely fastened. Follow directions on removing carriage (see page 16) and replacing carriage (see page 20). Clean new rollers with a soft, damp cloth prior to installing.

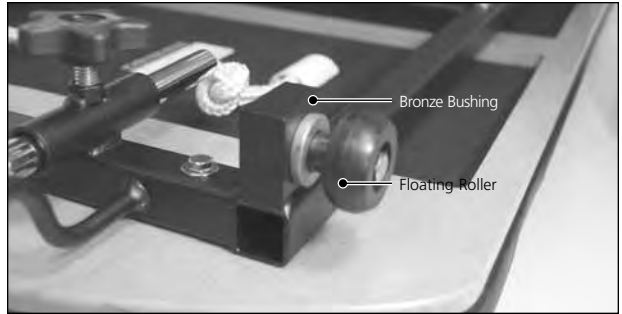

### Floating Rollers

With carriage removed from rails, slide floating rollers into bronze bushings. Then follow directions for replacing carriage (see page 20). Clean new rollers with a soft, damp cloth prior to installing.

**CAUTION:** Never use oil lubricants as they may damage rollers.

Visit [merrithew.com/shop/replacement-parts](http://merrithew.com/shop/replacement-parts) for these replacement parts and optional accessories

Traditional Spring Package, 5 Springs	ST-05057	Mat Converter, SPX – Black	ST-02075
High-Precision Spring Package, 5 Springs	ST-05058	Padded Long Spine Straps, pair	ST-02016
Power Up Spring Package, 5 Springs	ST-05098	Padded Platform Extender, SPX – Black	ST-02074
Carriage Stopper	ST-06012	Reformer Box, SPX – Black	ST-02000
Fixed Rollers, pair	ST-06013	Soft Reformer Loops, pair	ST-02009
Floating Rollers, pair	ST-06014	Shoulder Rest Pads, pair – Black	ST-02023
Foam-Grip Handles, pair	ST-02007	Spring Sleeve	ST-05070
Footbar, SPX (Double)	ST-05085	Spring Clip	ST-02020
Footstrap	ST-02018	Locking Spring Clip	ST-05064
Gripper Mat	ST-02022	Traditional Ropes, pair – Black	ST-06289
Maple Roll-Up Pole	ST-06008	Traditional Ropes, pair – White	ST-06016

# Removing the Carriage



1. To remove carriage, remove pulleybars and place on the floor, on either side of the aluminum rails.



2. Using a Phillips screwdriver, remove stopper plates.



3. Carefully slide carriage out of the aluminum rails keeping carriage level until completely free of rails. Turn carriage over ensuring rollers are secure and do not come in contact with the floor.

**NOTE:** Requires two people.



4. Place carriage face-down on the ground.

**NOTE:** Ensure carriage is placed on a soft surface that will not damage the vinyl.



## Required Tools

- 2x Open-End Wrenches
- 1/2" x 7/16" (13 mm x 11 mm)

# Removing the Springs

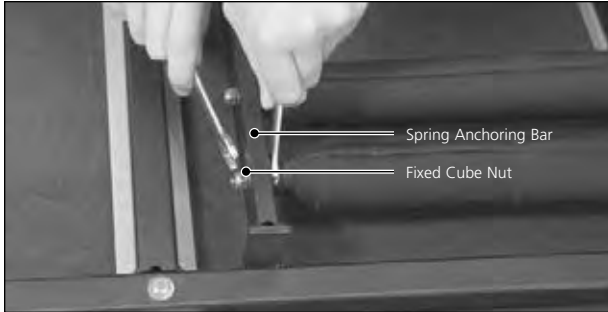

1. With 7/16" wrench, hold fixed cube nut in place.



2. Using second 7/16" wrench on opposite side of spring anchoring bar, loosen nylon locknut. This may require exerting a bit of torque.

**NOTE:** Discard used nylon locknuts and washers. (New nylon locknuts and washers are provided with new springs).



3. Remove spring from spring anchoring bar.



4. Pull spring out of the spring holder.

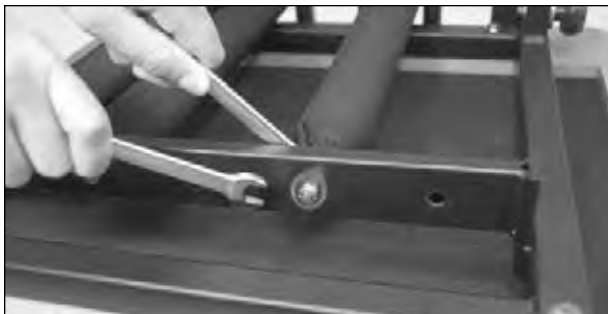

5. Repeat steps 1 to 4 on remaining springs.



6. Remove spring sleeves from old springs and slide onto new springs, if applicable.

# Replacing the Springs

Determine desired replacement spring package.

Springs balls are color-coded. Black = 125%, Red = 100%, Blue = 50%, White = 25%

**NOTE:** MPX Reformers arrive with the Traditional Spring Package.

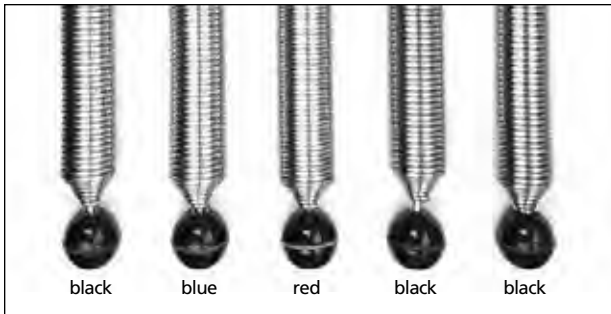

## Power Up Spring Package

**3 × 125%, 1 × 100%, 1 × 50%** arrange as follows:

Place the red (100%) spring in the center, and the blue (50%) spring to one side. Place black (125%) springs in the remaining positions.



**NOTE:** Spring sleeves are required for proper function of the Reformer if it features a molded spring holder.

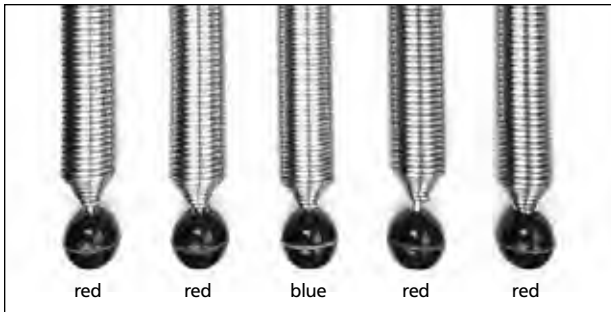

## Traditional Spring Package

**4 × 100%, 1 × 50%** arrange as follows:

Place the blue (50%) spring in the center and two red (100%) springs on either side.

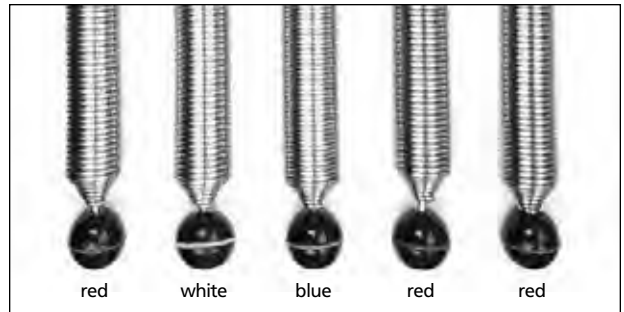

## High-Precision Spring Package

**3 × 100%, 1 × 50%, 1 × 25%** arrange as follows:

Place the blue (50%) spring in the center, and the white (25%) spring to one side. Place red (100%) springs in remaining positions.



**1.** Starting with spring #1 from your spring package, remove the nylon locknut and washer from bolt end of spring.



**2.** Start at one end of the carriage. Thread bolt end of spring #1 through first hole of molded spring holder.

### Required Tools

- 1x Phillips Screwdriver
- 2x Open-End Wrenches  
1/2" x 7/16" (13 mm x 11 mm)

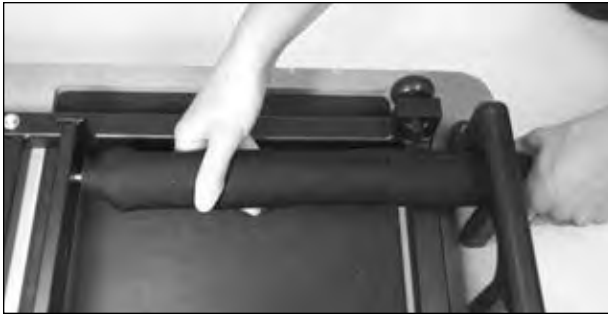

3. Insert spring bolt through the corresponding hole on spring anchoring bar.



4. Add washer and thread nylon locknut into spring bolt.

**NOTE:** Do not reuse old nylon locknuts or washers.

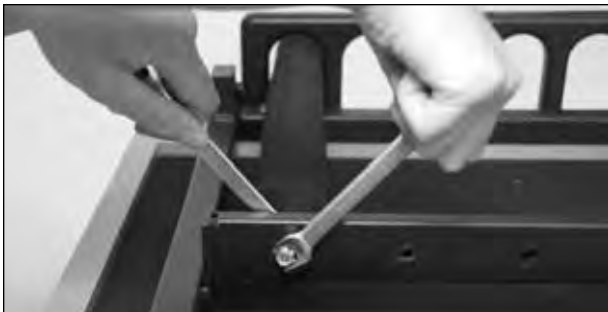

5. Hold fixed cube nut in place with 7/16" wrench. Using second wrench, tighten the new nylon locknut.

**CAUTION:** Do not overtighten.

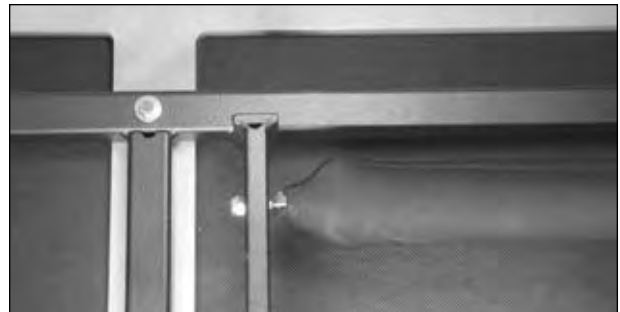

6. Both nylon locknut and fixed cube nut should be snug against the spring anchoring bar. Once secure, give the nylon locknut an additional 1/4 turn clockwise.

**CAUTION:** Do not overtighten.



7. Repeat steps 1 to 6 for remaining springs.



8. Affix the sticker provided with your spring replacement package to the underside of the Reformer carriage.

**Springs should be replaced every 24 months, or as needed within that period.**

# Replacing the Carriage



1. Remove carriage stopper.



2. Wipe inside of aluminum rails with a dry cloth to remove dust or dirt. If using a damp cloth, spray cleaner onto cloth first. Avoid spraying directly onto surfaces, rollers or aluminum rails. Insert carriage stopper in one of six positions.

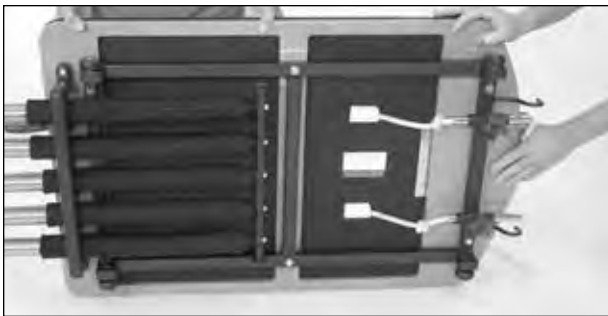

3. Ensure that pulleybars are still on the floor on either side of aluminum rails. Carefully turn carriage to its side while ensuring rollers never come in contact with the floor. Now, prepare for another person to take hold of opposite side of the carriage.



4. **CAUTION:** When guiding carriage straight into aluminum rails, move slowly and carefully as the rollers are sensitive. Once rollers are within rails they are protected.



5. Slide rollers into c-channels.

**NOTE:** To prevent damaging rollers, it is strongly advised two people hold carriage. One person guides rollers carefully into channels while the other supports opposite side of carriage. Once rollers are secured in channels, guide carriage into place.



6. Using a Phillips screwdriver, replace stopper plates.



7. Insert pulleybars into receptacles at rear of Reformer and fully tighten star knobs so pulleybars are secure. Ensure eyehooks on top of pulleybars are parallel to aluminum rails.



8. Replace gearbar and engage springs before resuming use of the Reformer.

# Warranty

Merrithew™ warrants that all new equipment is free of manufacturing defects in workmanship and materials, subject to the terms below. This warranty becomes effective at the invoice date of the original purchase. Parts repaired or replaced under the terms of this warranty will be warranted for the remainder of the original warranty period.

It is the purchaser's responsibility to notify Merrithew of any change of contact information. This ensures, that in the unlikely event of a replacement or safety notice, we are able to contact you immediately.

#### This warranty applies to equipment only:

- While it remains in the possession of the original purchaser and proof of purchase is demonstrated
- If claims are made within the part-specific warranty period
- If upgrades are made as required by Merrithew

#### This warranty shall be null and void if:

- **Equipment failure is a result of improper assembly, installation or maintenance**
- **The equipment is used for any other purpose other than as intended, or is stored or used outdoors, or in environments without adequate climate/humidity controls**
- **Equipment has been subjected to accident, misuse, abuse, improper service, or any modification not authorized by Merrithew**

This warranty does not cover damage to the finish of any equipment nor shipping charges, customs clearance fees (if applicable), or any costs incurred in installing repaired or replacement parts shipped under the provisions of this warranty.

Failure to change springs every two (2) years may void warranty.

#### 90-Day Upholstery Fabric Warranty

The vinyl fabric upholstery and spring sleeves will be replaced if they fail to give normal wear for 90 days after delivery. Proof of damage may be required. This warranty does not cover cuts, burns, stains, soiling, pet damage or damage caused by other unreasonable use. This warranty does not apply to fabrics cleaned with abrasive, corrosive or chemical cleansers. If the identical fabric is not available, Merrithew will provide an equivalent.

#### One (1) Year Limited Warranty

On fixed and floating rollers, ropes, straps, spring clips, plastic pulley post receptacle sleeves, comfort footbar, carriage stopper, molded spring holder, traditional Reformer feet and rubber stand feet. We recommend that spring clips (including those attached to traditional-style ropes) be changed annually.

#### Two (2) Year Limited Warranty

Merrithew will, at its option, repair or replace all other components including any of the parts listed below, provided such failure is due to a defect in workmanship or materials and provided such failure occurs and is reported to Merrithew within a period of two years from invoice date of the original purchase.

- Aluminum rails
- Gearbar
- Vertical stand legs
- Floating safety tabs
- Components of the frame and related welding
- Footbar mechanism (Includes swing arms, chrome adjuster bar and associated hardware, excludes footbar)
- Vertical stand legs
- Floating safety tabs

#### Disclaimer of Implied Warranties and Limitation of Remedies

Repair or replacement of defective parts is your exclusive remedy under the terms of this limited warranty. In the event of parts availability issues, Merrithew will not be responsible for any consequential or incidental damages arising from the breach of either this limited warranty or any applicable implied warranty, or for failure or damage resulting from acts of nature, improper care and maintenance, accident, alteration, replacement of parts by anyone other than Merrithew, misuse, transportation, abuse, hostile environments (inclement weather, acts of nature), improper installation or installation not in accordance with local codes or printed instructions.

**This limited warranty is the sole express warranty given by Merrithew. No product performance, specification or description wherever appearing is warranted by Merrithew except to the extent set forth in this limited warranty. Any implied warranty protection arising under the laws of any state, province or territory including implied warranty of merchantability or fitness for a particular purpose, or use, is hereby limited in duration to the duration of this limited warranty.**

Neither distributors, dealers, web resellers, nor the retailers selling this product have any authority to make any additional warranties or to promise remedies in addition to, or inconsistent with those stated above. Merrithew's maximum liability, in any event, shall not exceed the purchase price of the product paid by the original purchaser.

## IMPORTANT

Please keep this manual in a safe place.

If you have questions, issues or are missing parts:  
Do NOT return this unit to your local retailer,  
please contact the manufacturer directly.

[customercare@merrithew.com](mailto:customercare@merrithew.com)

416.482.4050 | 1.800.910.0001 | 0800.328.5676 UK | ext. 288

# Take Advantage of our Training Tools



**Training Manuals:** Three fully illustrated manuals, developed for our Instructor Training Program, offer step-by-step instruction to the complete Reformer repertoire.

**Wall Charts:** Full-size posters, measuring 27"x 39", depict exercises featured in the STOTT PILATES® Reformer repertoire. Each exercise is described with name, equipment accessories, one photo, and suggested repetitions.



**Instructional DVDs:** We offer almost limitless exercise challenges in our clear and detailed repertoire of cutting edge titles. For a full listing visit [merrithew.com/shop/dvds](http://merrithew.com/shop/dvds)



**NEW**

◆ merrithew connect.

Check out Merrithew's digital platform with 200+ workouts. Visit [merrithewconnect.com](http://merrithewconnect.com)



## Make the Most of Merrithew Equipment

As Leaders in Mindful Movement™, Merrithew is committed to developing unique, top-quality fitness programs based on the latest in exercise science and research. Our signature STOTT PILATES® education is unparalleled, and we bring the same expertise and passion to our full range of branded programs, including CORE™ Athletic Conditioning and Performance Training™, ZEN•GA®, Total Barre® and Halo® Training. Join our global community of elite fitness professionals. Merrithew courses and workshops are offered worldwide.

Find courses and workshops near you at [merrithew.com/education/training](http://merrithew.com/education/training)

Contact Us 416.482.4050 | 1.800.910.0001 | 0800.328.5676 UK | ext. 300



# IMPORTANT

Please keep this manual in a safe place.



## Go to [merrithew.com/warranty](https://merrithew.com/warranty) to activate your warranty!

Get the benefits:

- Ensure that you'll be able to repair it under warranty should you encounter a problem.
- Make warranty service fast and efficient by having your information in our records.
- In the unlikely event of a replacement or safety notice, we'll be able to contact you immediately.
- Proof of purchase for insurance purposes in the event of a loss due to fire, flood or theft.
- Stay informed of any product updates.

### Can't get online?

Please fill out the warranty card enclosed with this product, and return to us.

This is your Reformer Serial Number:



2200 Yonge Street, Suite 500, Toronto, Ontario, Canada M4S 2C6  
416.482.4050 | 1.800.910.0001 | 0800.328.5676 UK | ext. 288  
customer@care@merrithew.com | [merrithew.com](https://merrithew.com)